

# S2M0025120J

## 1200V SiC POWER MOSFET

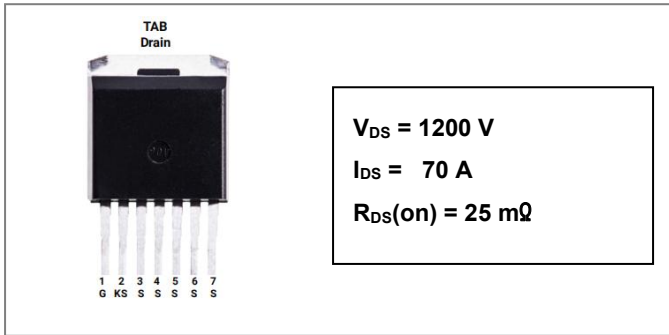

### Description

S2M0025120J is single SiC Power MOSFET packaged in TO-263-7 case. The device is a high voltage n-channel enhancement mode MOSFET that has very low total conduction losses and very stable switching characteristics over temperature extremes. The S2M0025120J is ideal for energy sensitive, high frequency applications in challenging environments.

### Circuit Diagram

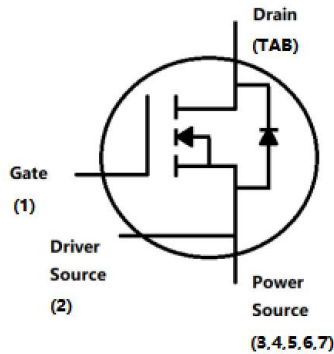

### Features

- Positive temperature characteristics, easy to parallel.
- Low on-resistance Typ.  $R_{DS(on)} = 25\text{m}\Omega$  .
- Fast switching speed and low switching losses.
- Very fast and robust intrinsic body diode.
- Process of non-bright Tin electroplatin

### Applications

- EV Fast Charging Modules
- EV On Board Chargers
- Solar Inverters
- Online UPS/Industrial UPS
- SMPS (Switch Mode Power Supplies)
- DC-DC Converters
- ESS (Energy Storage Systems)

### Maximum Ratings(T=25°C unless otherwise specified)

Characteristics	Symbol	Condition	Max.	Units
Drain Source Voltage	$V_{DSS}$	$V_{GS} = 0V, I_{DS} = 100\mu A, T_J = 25^\circ C$	1200	V
Gate Source Voltage	$V_{GSS}$	$T_J = 25^\circ C$ , Absolute maximum values, AC ( $f > 1\text{Hz}$ )	-10 to +25	V
Gate Source Voltage	$V_{GSOP}$	$T_J = 25^\circ C$ Recommended Operational Values	-5 to +20	V
Continuous Drain Current	$I_D$	$V_{GS} = 20V, T_J = 25^\circ C$	70	A
	$I_D$	$V_{GS} = 20V, T_J = 100^\circ C$	50	A
Pulsed Drain Current	$I_{D,pulse}$	Pulse width $t_P$ limited by $T_{jmax}$	250	A
Power Dissipation	$P_D$	$T_C = 25^\circ C, T_J = 175^\circ C$	311	W
Solder Temperature	TL	1.6mm (0.063") from case for 10s	260	°C

**Electrical Characteristics(T=25°C unless otherwise specified)**

Characteristics	Symbol	Condition	Min.	Typ.	Max.	Units
Drain Source Breakdown Voltage	$V_{(BR)DSS}$	$V_{GS} = 0V, I_D = 100\mu A$	1200			V
Gate Threshold Voltage	$V_{GS(th)}$	$V_{DS} = V_{GS}, I_D = 15mA$	1.8	2.6	4	V
		$V_{DS} = V_{GS}, I_D = 15mA, T_J = 175^\circ C$		1.8		V
Zero Gate Voltage Drain Current	$I_{DSS}$	$V_{DS} = 1200V, V_{GS} = 0V$		2	100	$\mu A$
Gate Source Leakage Current	$I_{GSS}$	$V_{GS} = 20V, V_{DS} = 0V$			250	nA
Drain Source On-State Resistance	$R_{DS(on)}$	$V_{GS} = 20V, I_D = 50A$		25	34	m $\Omega$
		$V_{GS} = 20V, I_D = 50A, T_J = 175^\circ C$		41		m $\Omega$
Transconductance	gfs	$V_{DS} = 20V, I_{DS} = 50A$		16		S
		$V_{DS} = 20V, I_{DS} = 50A, T_J = 175^\circ C$		18		S
Input Capacitance	$C_{ISS}$	$V_{GS} = 0V,$		4150		pF
Output Capacitance	$C_{OSS}$	$V_{DS} = 1000V$		201		
Reverse Transfer Capacitance	$C_{RSS}$	$V_{AC} = 25mV$		5		
$C_{OSS}$ Stored Energy	$E_{OSS}$	$f = 500KHz$		81.93		$\mu J$
Turn-On Switching Energy	$E_{ON}$	$V_{DS} = 800V, V_{GS} = -5/20V$		0.74		mJ
Turn-Off Switching Energy	$E_{OFF}$	$I_D = 50A, R_{G(ext)} = 2.5\Omega$		0.15		
Turn-On Delay Time	$t_{d(on)}$	$V_{DS} = 800V, V_{GS} = -5/20V$		29		ns
Rise Time	$t_r$	$I_D = 50A, R_{G(ext)} = 2.5\Omega$		15		
Turn-Off Delay Time	$t_{d(off)}$			37		
Fall Time	$t_f$			12		
Internal Gate Resistance	$R_{G(int)}$	$f = 1MHz, V_{AC} = 25mV$		2.8		$\Omega$
Gate to Source Charge	$Q_{gs}$	$V_{DS} = 800V, V_{GS} = -5/20V$		88		nC
Gate to Drain Charge	$Q_{gd}$	$I_D = 50A$		17		
Total Gate Charge	$Q_g$			177		

**Reverse Diode Characteristics:**

Characteristics	Symbol	Condition	Typ.	Max.	Units	
Diode Forward Voltage	$V_{SD}$	$V_{GS} = -5V, I_{SD} = 25A$	4.3		V	
		$V_{GS} = -5V, I_{SD} = 25A, T_J = 175^\circ C$	3.9		V	
Continuous Diode Forward Current	$I_S$	$V_{GS} = -5V, T_C = 25^\circ C$		44	A	
Reverse Recovery Time	$t_{rr}$	$V_{GS} = -5V, I_{SD} = 50A, T_J = 25^\circ C$	131		ns	
Reverse Recovery Charge	$Q_{rr}$		$V_R = 800V$	330		nC
Peak Reverse Recovery Current	$I_{mm}$		$diff/dt = 1057A/\mu s$	6.3		A

**Thermal-Mechanical Specifications:**

Characteristics	Symbol	Condition	Specification	Units
Junction Temperature	$T_J$	-	-55 to +175	$^\circ C$
Storage Temperature	$T_{stg}$	-	-55 to +175	$^\circ C$
Typical Thermal Resistance Junction to Case	$R_{\theta JC}$	DC operation	0.48	$^\circ C/W$
Typical Thermal Resistance Junction to Ambient	$R_{\theta JA}$		60	$^\circ C/W$

**Ordering Information:**

Device	Package	Shipping
S2M0025120J	TO-263-7	50pcs/tube
S2M0025120JTR	TO-263-7	800pcs/reel

**Marking Diagram**

Where XXXXX is YYWWL

S2M = Device Type  
 0025 =  $R_{\theta s(on)}$   
 120 = Reverse Voltage (1200V)  
 J = Package  
 SSG = SSG  
 YY = Year  
 WW = Week  
 L = Lot Number

**Cautions:** Molding resin  
 Epoxy resin UL:94V-0

**Ratings and Characteristics Curves**

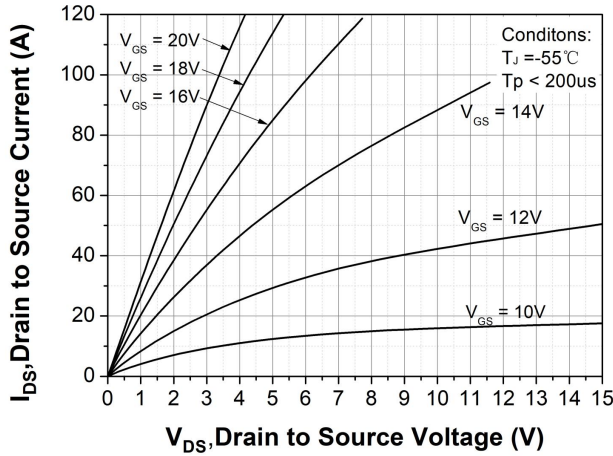

Figure 1. Output Characteristics  $T_J = -55^\circ\text{C}$

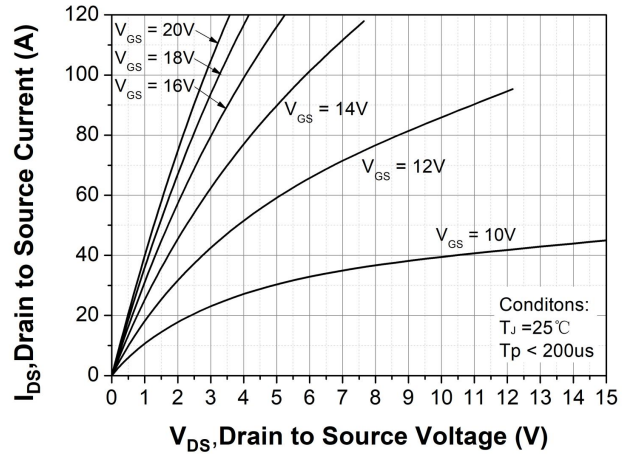

Figure 2. Output Characteristics  $T_J = 25^\circ\text{C}$

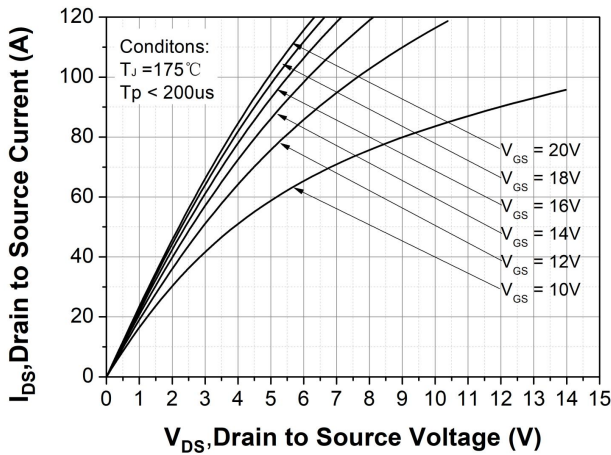

Figure 3. Output Characteristics  $T_J = 175^\circ\text{C}$

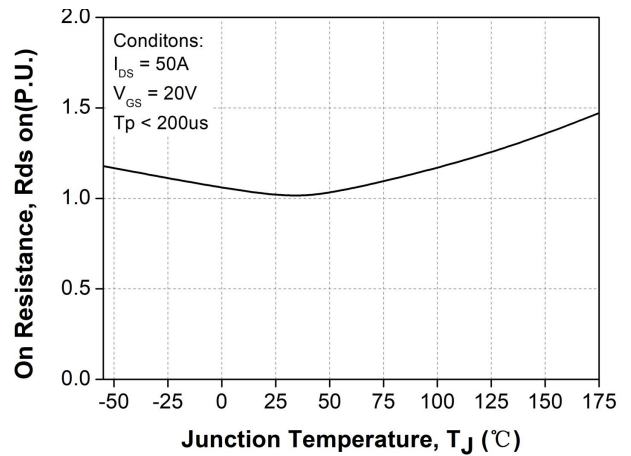

Figure 4. Normalized On-Resistance vs. Temperature

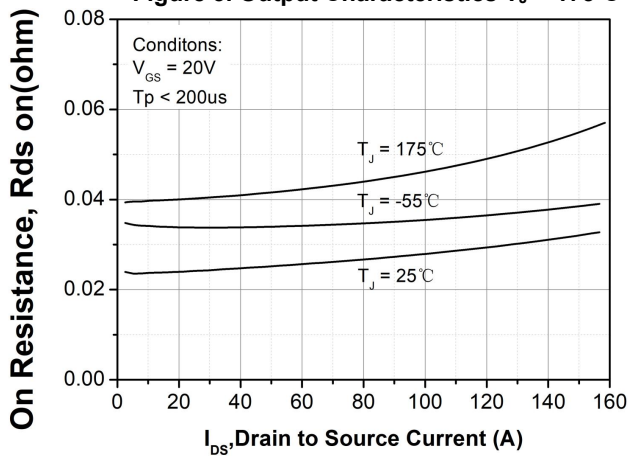

Figure 5. On-Resistance vs. Drain Current For Various Temperatures

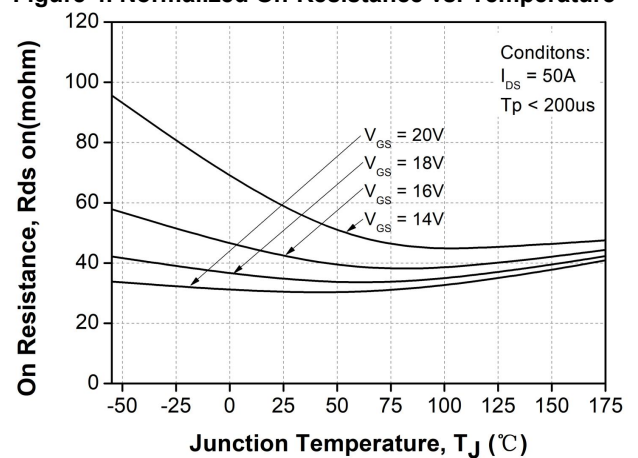
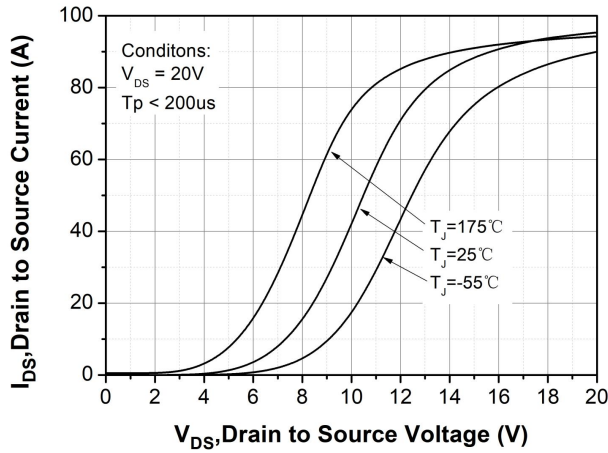
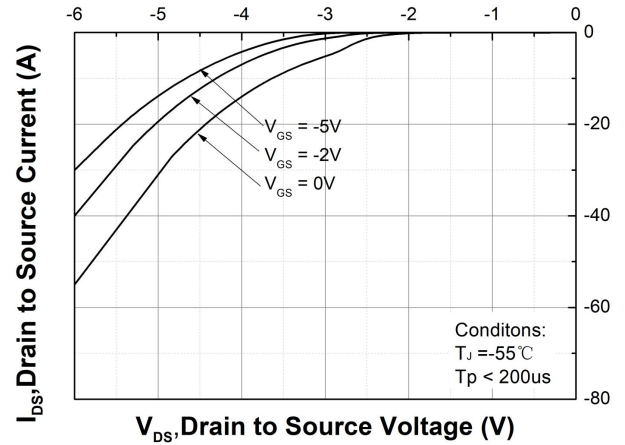

Figure 6. On-Resistance vs. Temperature For Various Gate Voltage

**Technical Data**  
Data Sheet N2482, REV.-



**Figure 7. Transfer Characteristic for Various Junction Temperatures**



**Figure 8. Body Diode Characteristic at  $T_J = -55^\circ C$**

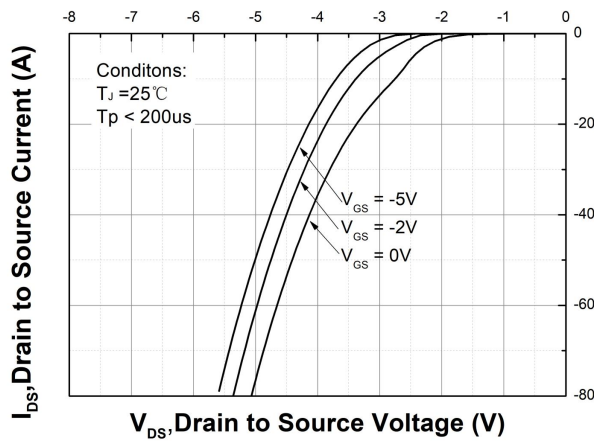

**Figure 9. Body Diode Characteristic at  $T_J = 25^\circ C$**

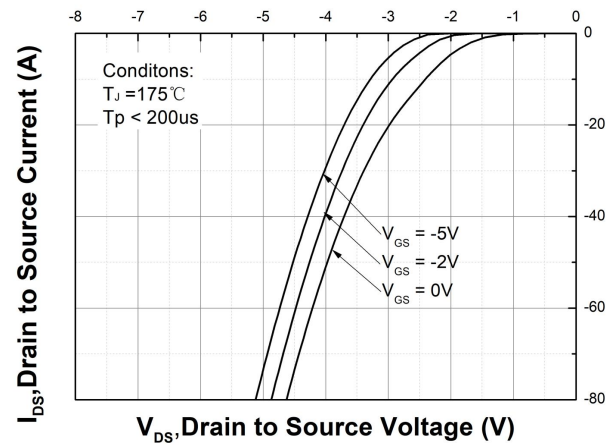

**Figure 10. Body Diode Characteristic at  $T_J = 175^\circ C$**

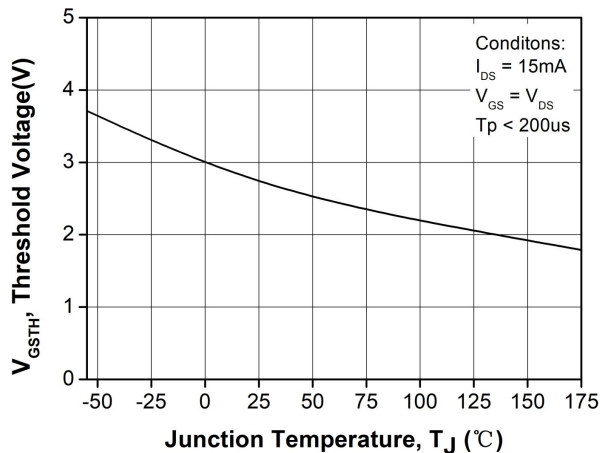

**Figure 11. Threshold Voltage vs. Temperature**

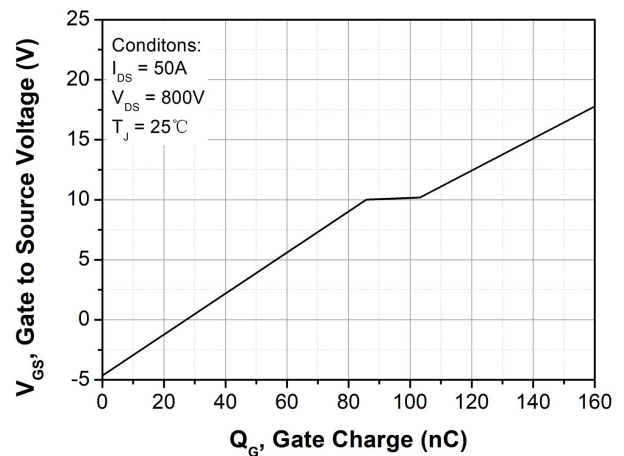

**Figure 12. Gate Charge Characteristic**

**Technical Data**  
Data Sheet N2482, REV.-

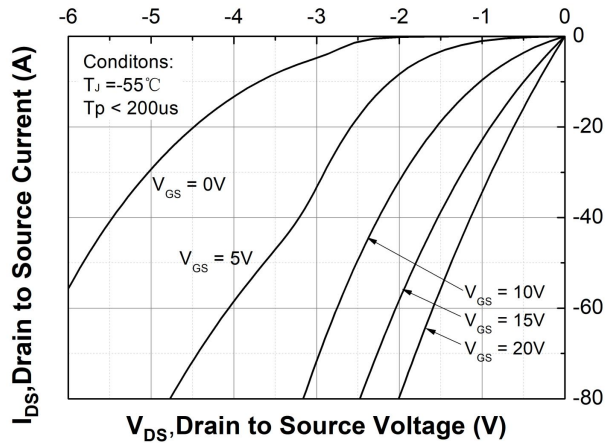

Figure 13. 3rd Quadrant Characteristic at  $T_J = -55^\circ\text{C}$

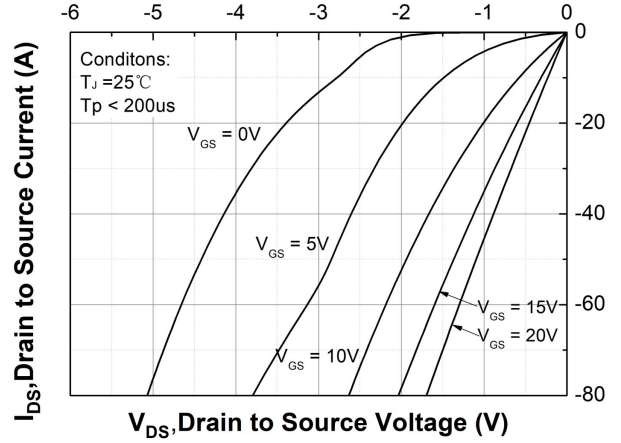

Figure 14. 3rd Quadrant Characteristic at  $T_J = 25^\circ\text{C}$

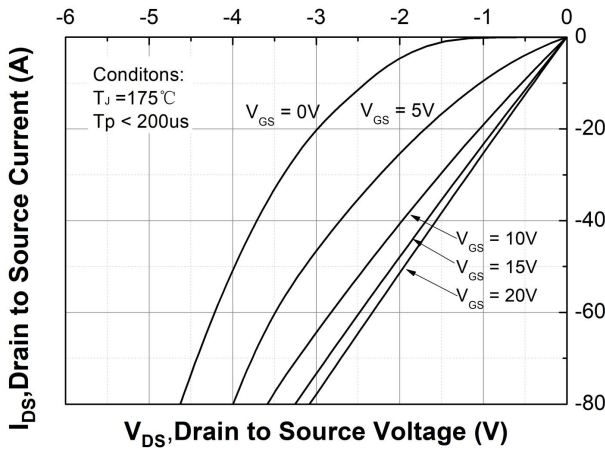

Figure 15. 3rd Quadrant Characteristic at  $T_J = 175^\circ\text{C}$

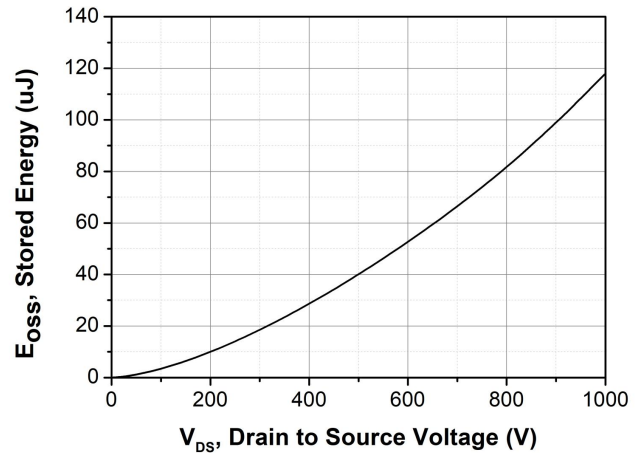

Figure 16. Output Capacitor Stored Energy

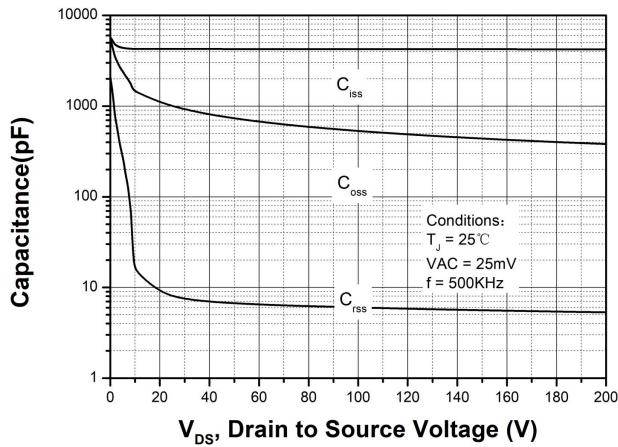

Figure 17. Capacitances vs. Drain-Source Voltage (0 - 200V)

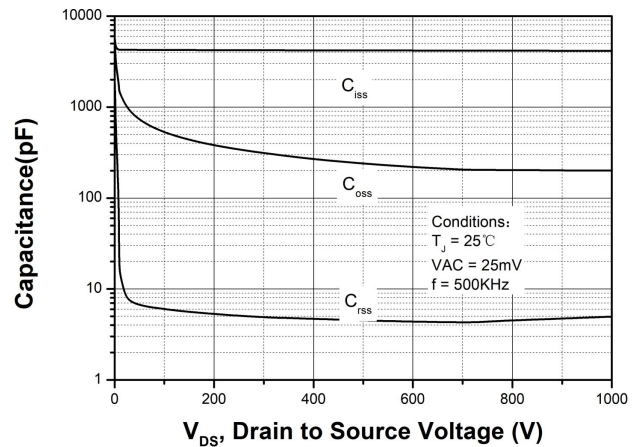
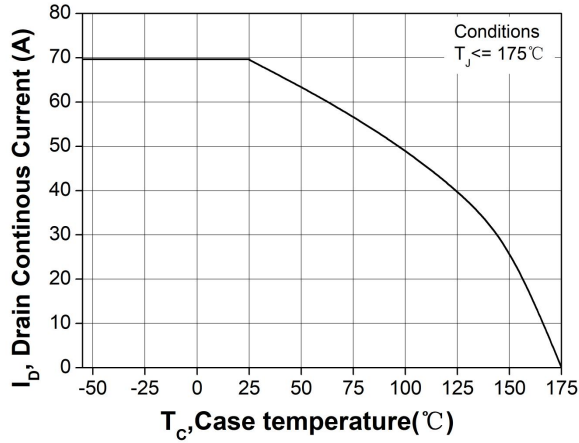
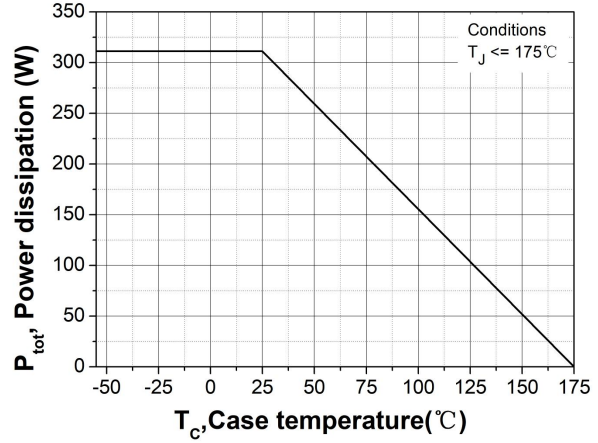

Figure 18. Capacitances vs. Drain-Source Voltage (0 - 1000V)

**Technical Data**  
Data Sheet N2482, REV.-



**Figure 19. Continuous Drain Current Derating vs. Case Temperature**



**Figure 20. Maximum Power Dissipation Derating vs. Case Temperature**

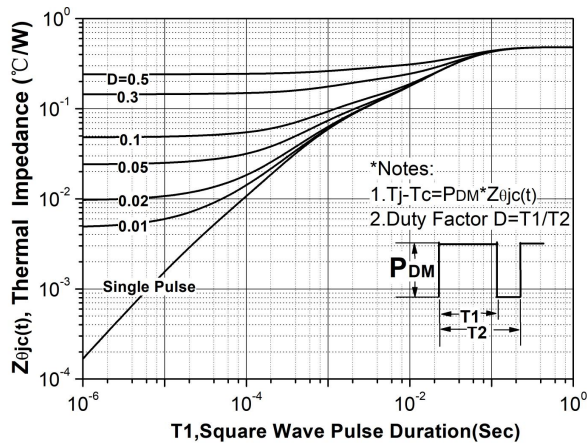

**Figure 21. Transient Thermal Impedance (Junction - Case)**

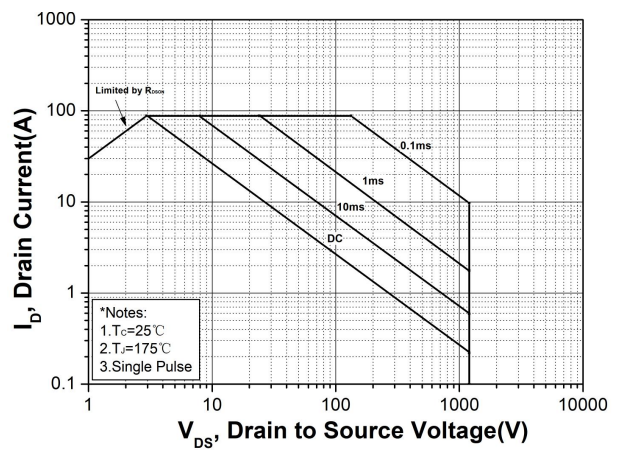

**Figure 22. Safe Operating Area**

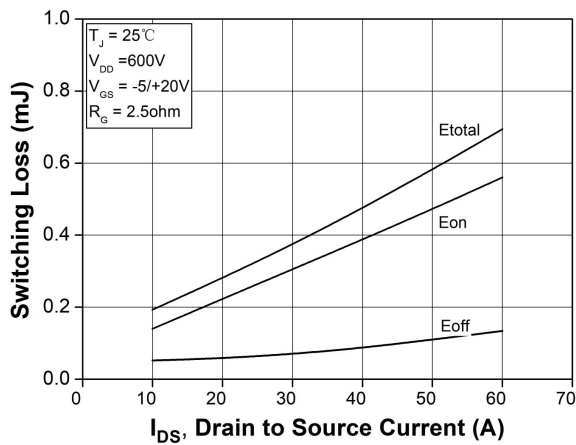

**Figure 23. Clamped Inductive Switching Energy vs. Drain Current (V<sub>DD</sub> = 600V)**

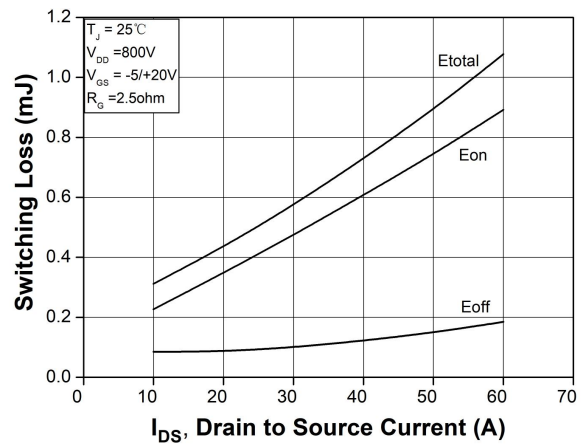

**Figure 24. Clamped Inductive Switching Energy vs. Drain Current (V<sub>DD</sub> = 800V)**

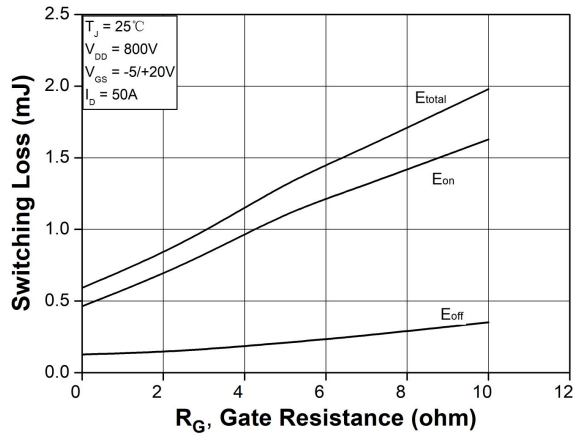

Figure 25. Clamped Inductive Switching Energy vs.  $R_{G(ext)}$

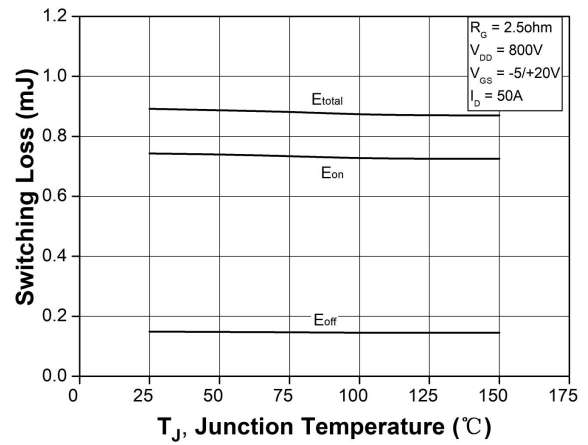

Figure 26. Clamped Inductive Switching Energy vs. Temperature

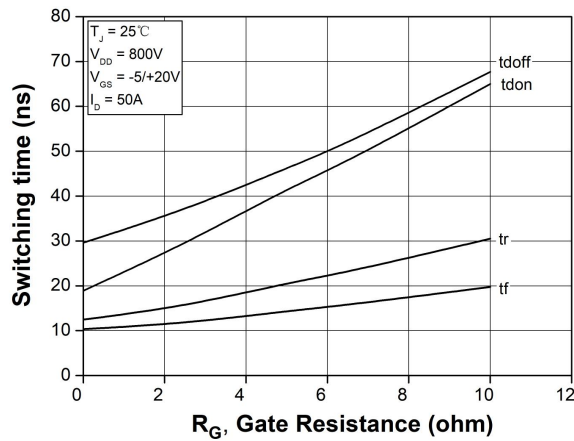

Figure 27. Switching Times vs.  $R_{G(ext)}$

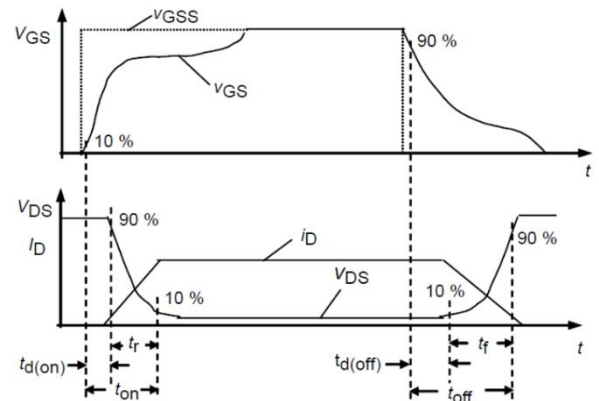
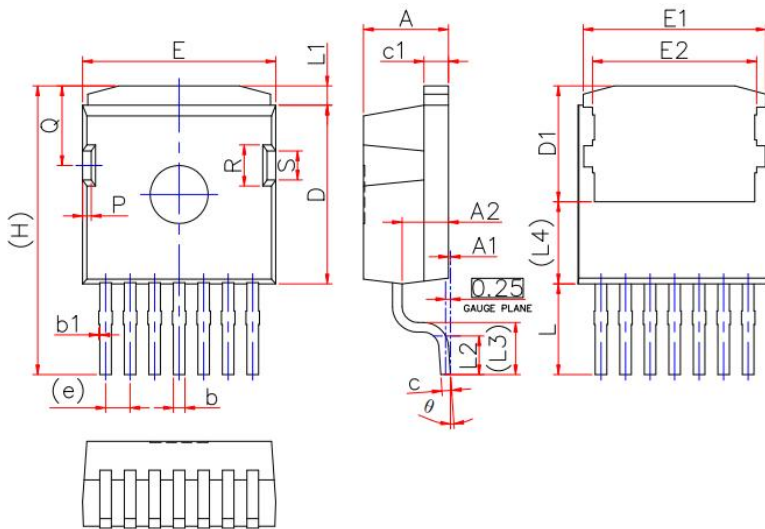

Figure 28. Switching Times Definition



**Mechanical Dimensions TO-263-7**



SYMBOL	Millimeters		
	TYP.	MAX.	MIN.
A	4.3	4.4	4.5
A1	0	0.1	0.2
A2	2.3	2.4	2.5
b	0.5	0.6	0.7
b1	0	0.075	0.15
c	0.4	0.5	0.6
c1	1.17	1.27	1.37
D	9.05	9.25	9.45
D1	5.9	6	6.1
E	9.8	10	10.2
E1	9.36	9.46	9.56
E2	8.4	8.5	8.6
e	1.270 REF		
H	15.000 REF		
L	4.2	4.7	5.2
L1	0.7	1	1.3
L2	1.7	2	2.3
L3	2.700 REF		
L4	4.250 REF		
P	0.35	0.45	0.55
Q	4.02	4.12	4.22
R	2.03	2.13	2.23
S	1.4	1.5	1.6
θ	4°	8°	0°

**DISCLAIMER:**

- 1- The information given herein, including the specifications and dimensions, is subject to change without prior notice to improve product characteristics. Before ordering, purchasers are advised to contact the SMC Diode Solutions sales department for the latest version of the datasheet(s).
- 2- In cases where extremely high reliability is required (such as use in nuclear power control, aerospace and aviation, traffic equipment, medical equipment, and safety equipment), safety should be ensured by using semiconductor devices that feature assured safety or by means of users' fail-safe precautions or other arrangement.
- 3- In no event shall SMC Diode Solutions be liable for any damages that may result from an accident or any other cause during operation of the user's units according to the datasheet(s). SMC Diode Solution assumes no responsibility for any intellectual property claims or any other problems that may result from applications of information, products or circuits described in the datasheets.
- 4- In no event shall SMC Diode Solutions be liable for any failure in a semiconductor device or any secondary damage resulting from use at a value exceeding the absolute maximum rating.
- 5- No license is granted by the datasheet(s) under any patents or other rights of any third party or SMC Diode Solutions.
- 6- The datasheet(s) may not be reproduced or duplicated, in any form, in whole or part, without the expressed written permission of SMC Diode Solutions.
- 7- The products (technologies) described in the datasheet(s) are not to be provided to any party whose purpose in their application will hinder maintenance of international peace and safety nor are they to be applied to that purpose by their direct purchasers or any third party. When exporting these products (technologies), the necessary procedures are to be taken in accordance with related laws and regulations..